

3M x 3M WORLD OF FINE DINING BOOTH

三米乘三米標準攤位

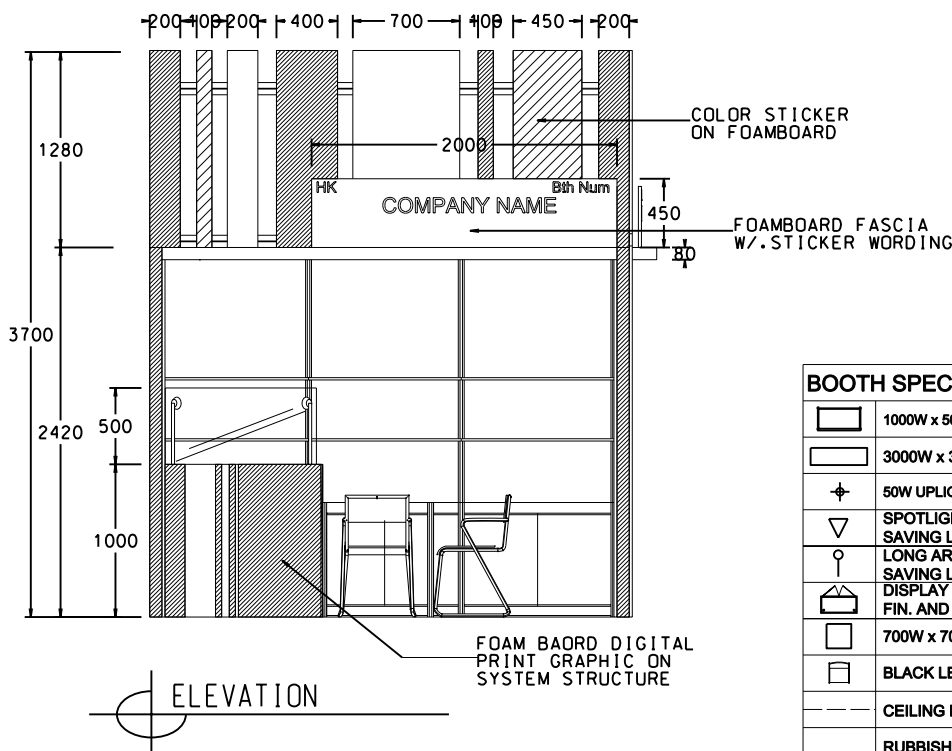
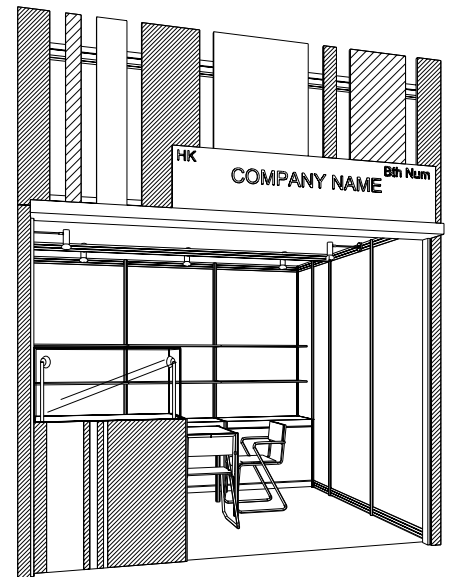
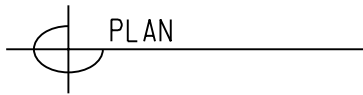
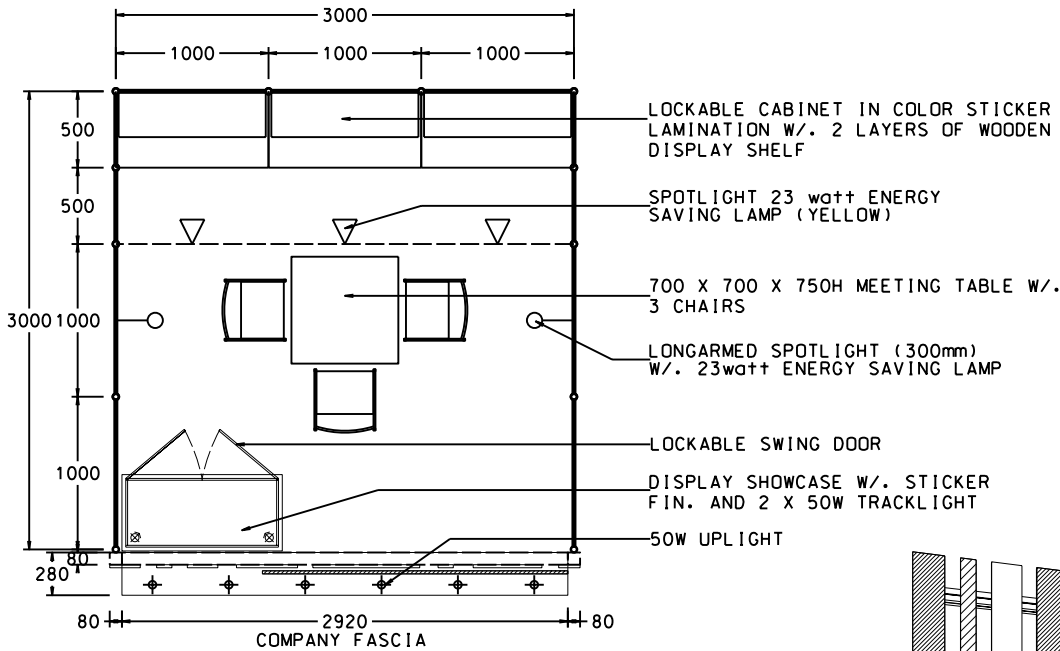

BOOTH SPECIFICATIONS		QTY.
	1000W x 500D x 750H CABINET	3
	3000W x 300D WOODEN DISPLAY SHELF	2
	50W UPLIGHT	6
	SPOTLIGHT 23 WATT ENERGY SAVING LAMP (YELLOW LIGHT)	3
	LONG ARMED SPOTLIGHT (300MM) 23 WATT ENERGY SAVING LAMP (YELLOW LIGHT)	2
	DISPLAY SHOWCASE W/. STICKER FIN. AND 2 X 50W TRACKLIGHT	1
	700W x 700D x 750H MEETING TABLE	1
	BLACK LEATHER CHAIR	3
	CEILING BEAM	3M
	RUBBISH BIN & CARPET (9sqm.)	

3M x 3M WORLD OF FINE DINING CORNER BOOTH

三米乘三米角位攤位

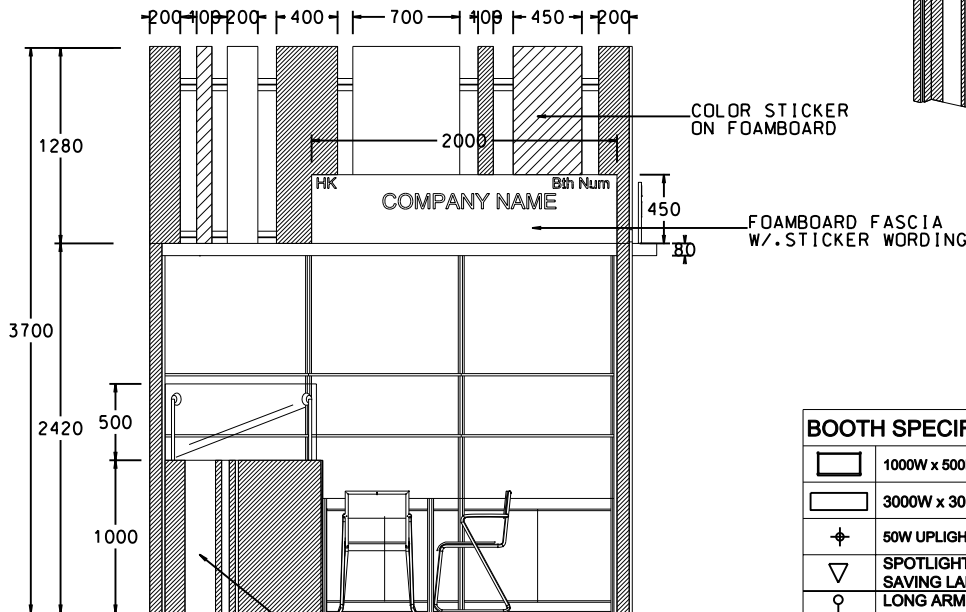
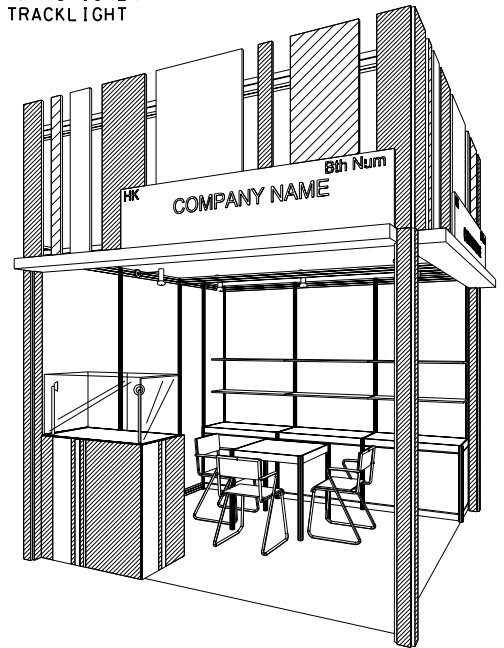
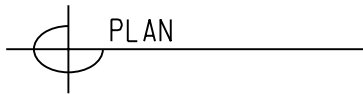
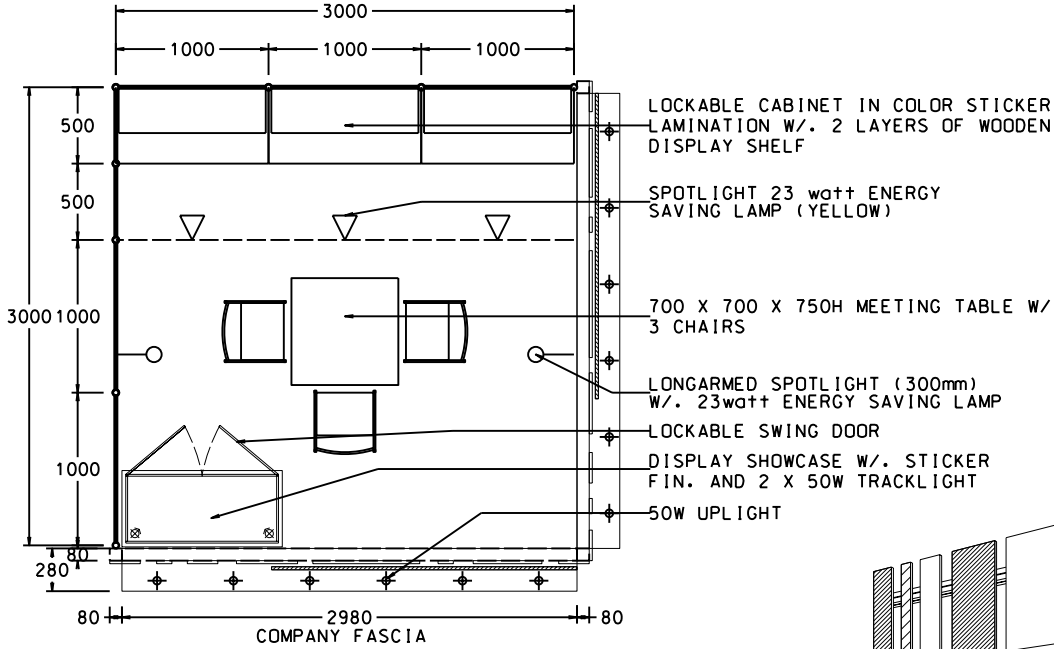

FOAM BOARD DIGITAL PRINT GRAPHIC ON SYSTEM STRUCTURE

BOOTH SPECIFICATIONS		QTY.
	1000W x 500D x 750H CABINET	3
	3000W x 300D WOODEN DISPLAY SHELF	2
	50W UPLIGHT	12
	SPOTLIGHT 23 WATT ENERGY SAVING LAMP (YELLOW LIGHT)	3
	LONG ARMED SPOTLIGHT (300MM) 23 WATT ENERGY SAVING LAMP (YELLOW LIGHT)	2
	DISPLAY SHOWCASE W/. STICKER FIN. AND 2 X 50W TRACKLIGHT	1
	700W x 700D x 750H MEETING TABLE	1
	BLACK LEATHER CHAIR	3
	CEILING BEAM	3M
	RUBBISH BIN & CARPET (9sqm.)	

4M x 3M WORLD OF FINE DINING BOOTH

四米乘三米標準攤位

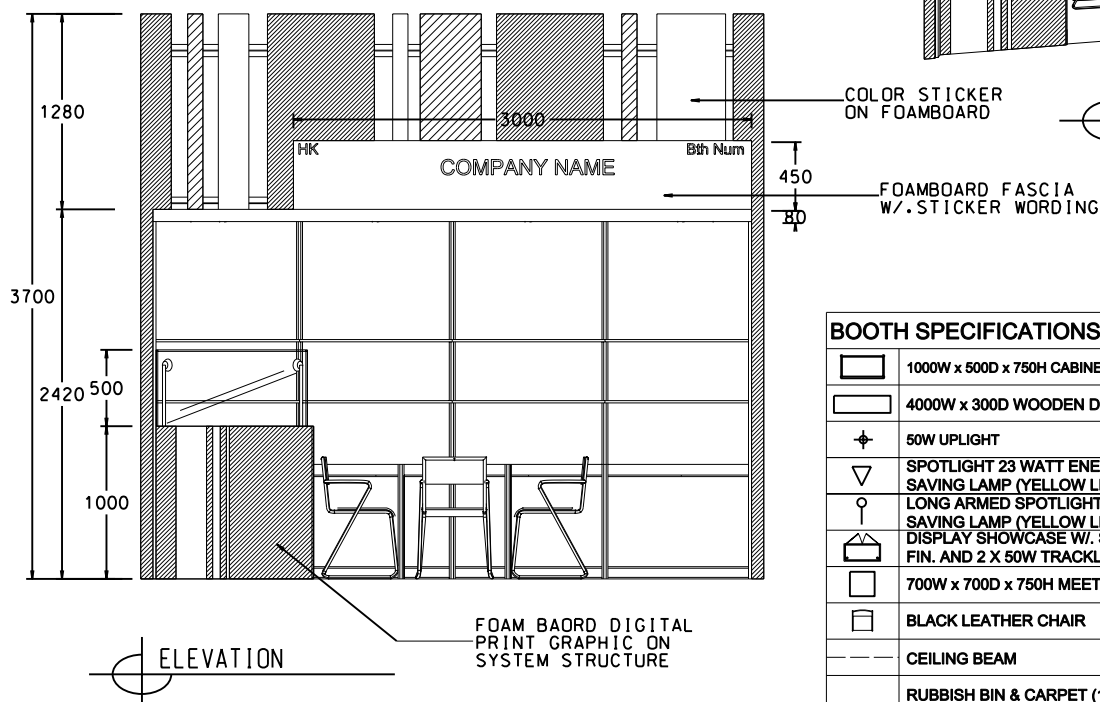
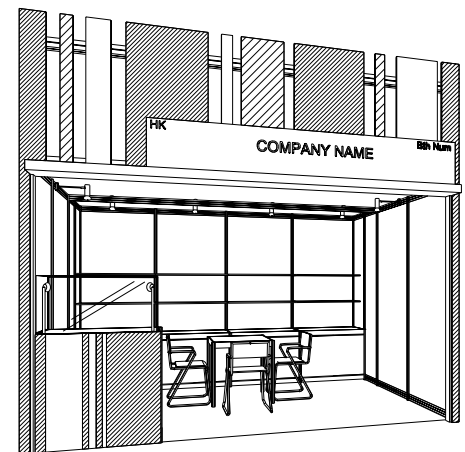
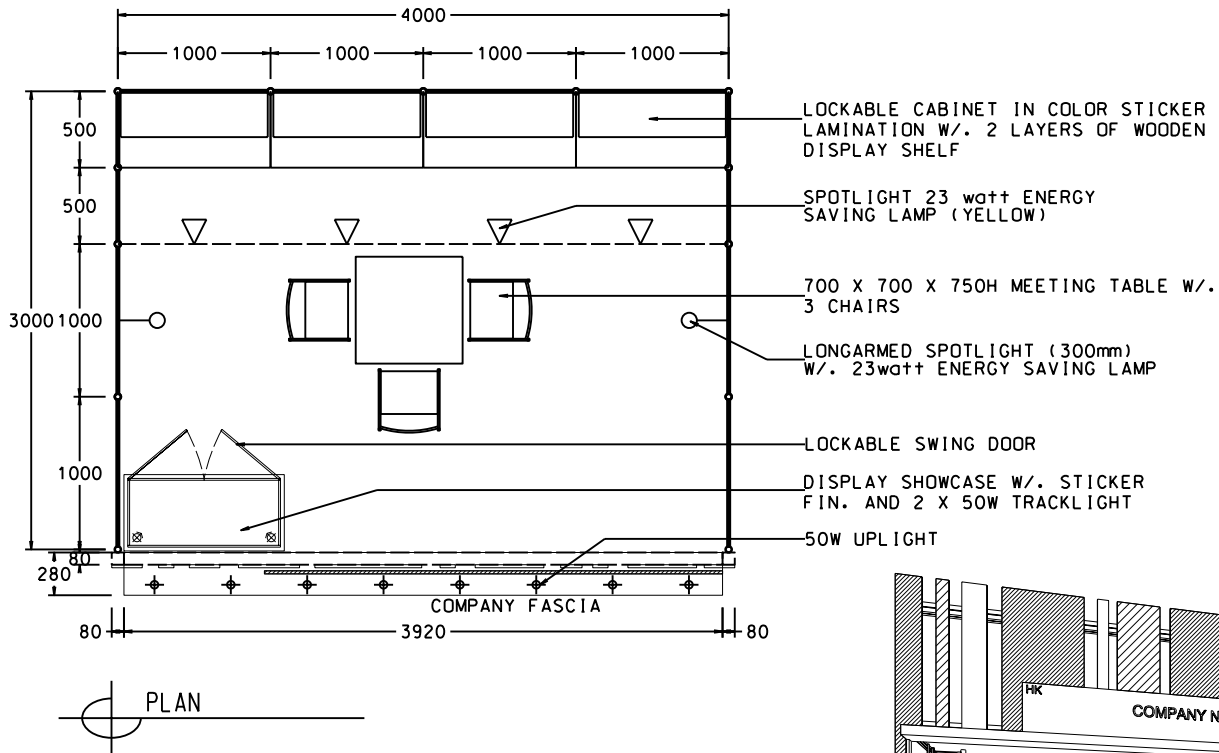

BOOTH SPECIFICATIONS		QTY.
	1000W x 500D x 750H CABINET	4
	4000W x 300D WOODEN DISPLAY SHELF	2
	50W UPLIGHT	8
	SPOTLIGHT 23 WATT ENERGY SAVING LAMP (YELLOW LIGHT)	4
	LONG ARMED SPOTLIGHT (300MM) 23 WATT ENERGY SAVING LAMP (YELLOW LIGHT)	2
	DISPLAY SHOWCASE W/. STICKER FIN. AND 2 X 50W TRACKLIGHT	1
	700W x 700D x 750H MEETING TABLE	1
	BLACK LEATHER CHAIR	3
	CEILING BEAM	4M
	RUBBISH BIN & CARPET (12sqm.)	

4M x 3M WORLD OF FINE DINING CORNER BOOTH

四米乘三米角位攤位

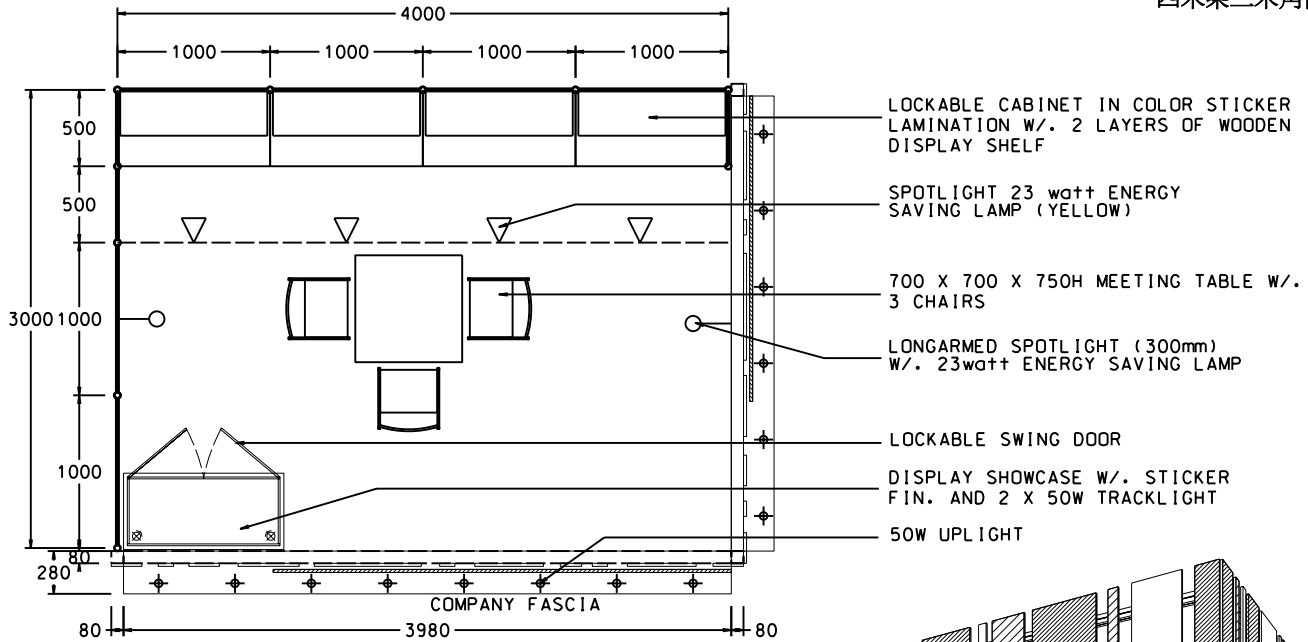

PLAN

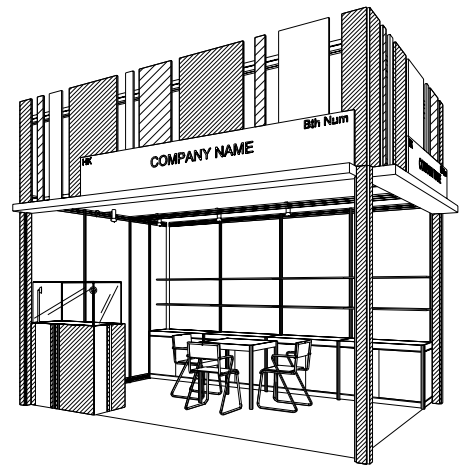

PERSPECTIVE

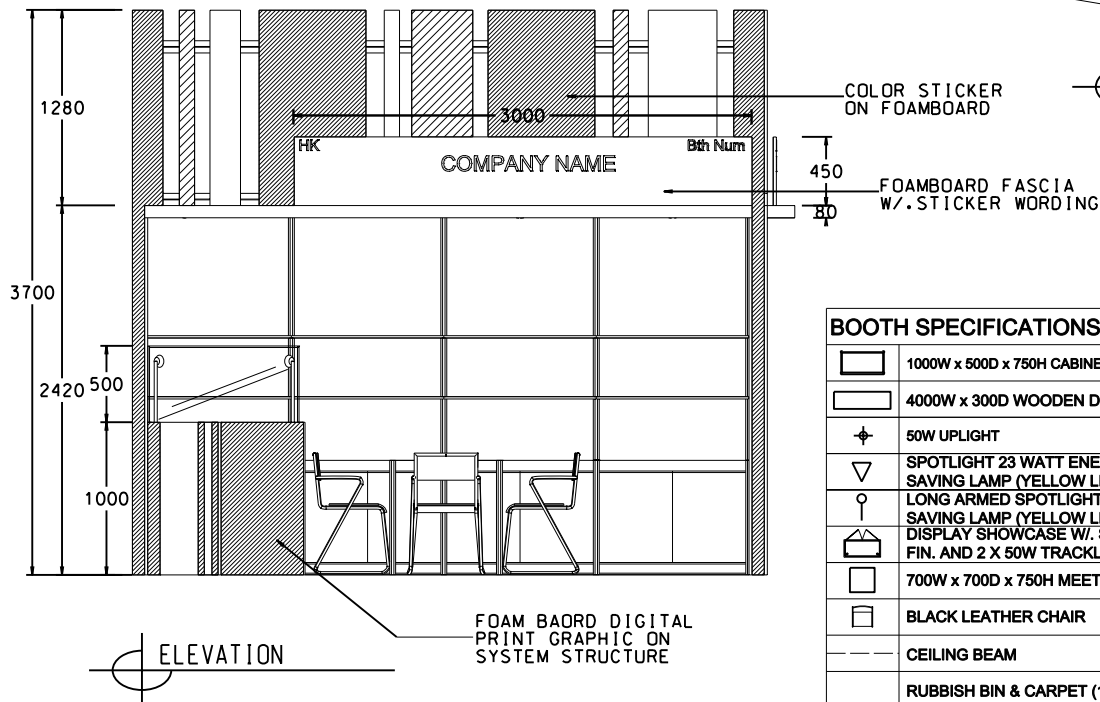

ELEVATION

BOOTH SPECIFICATIONS		QTY.
	1000W x 500D x 750H CABINET	4
	4000W x 300D WOODEN DISPLAY SHELF	2
	50W UPLIGHT	14
	SPOTLIGHT 23 WATT ENERGY SAVING LAMP (YELLOW LIGHT)	4
	LONG ARMED SPOTLIGHT (300MM) 23 WATT ENERGY SAVING LAMP (YELLOW LIGHT)	2
	DISPLAY SHOWCASE W/. STICKER FIN. AND 2 X 50W TRACKLIGHT	1
	700W x 700D x 750H MEETING TABLE	1
	BLACK LEATHER CHAIR	3
	CEILING BEAM	4M
	RUBBISH BIN & CARPET (12sqm.)	

5M x 3M WORLD OF FINE DINING BOOTH

五米乘三米標準攤位

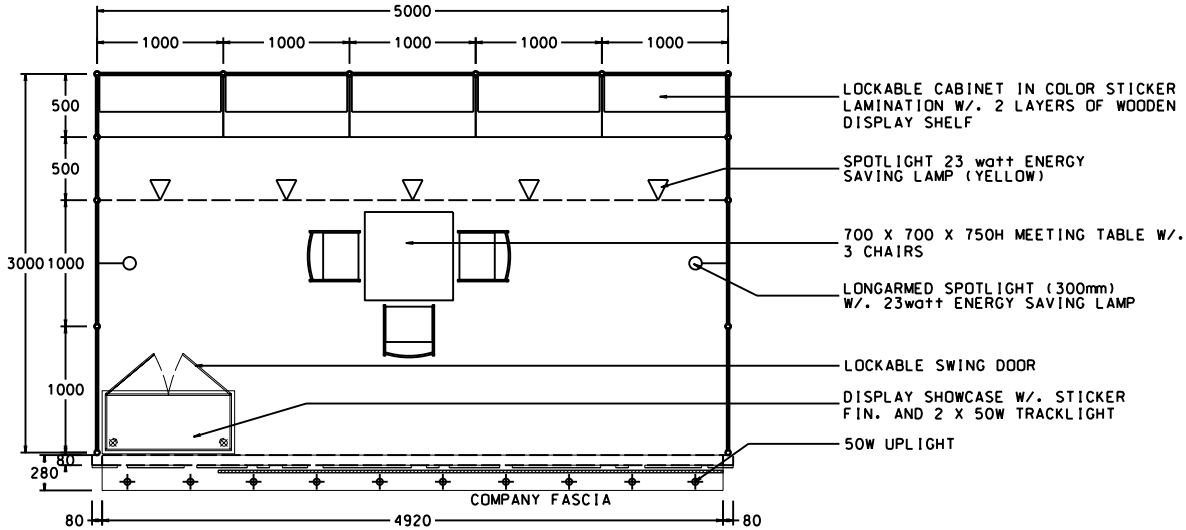

PLAN

PERSPECTIVE

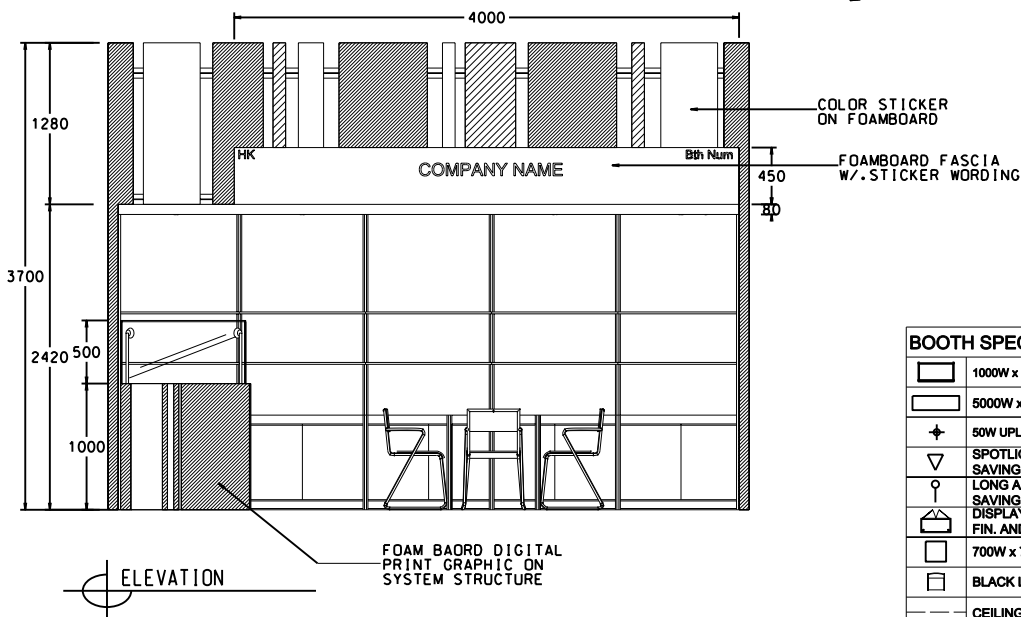
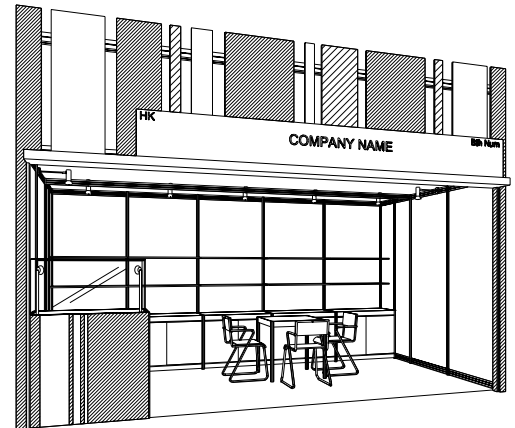

ELEVATION

BOOTH SPECIFICATIONS		QTY.
	1000W x 500D x 750H CABINET	5
	5000W x 300D WOODEN DISPLAY SHELF	2
	50W UPLIGHT	10
	SPOTLIGHT 23 WATT ENERGY SAVING LAMP (YELLOW LIGHT)	5
	LONG ARMED SPOTLIGHT (300MM) 23 WATT ENERGY SAVING LAMP (YELLOW LIGHT)	2
	DISPLAY SHOWCASE W/. STICKER FIN. AND 2 x 50W TRACKLIGHT	1
	700W x 700D x 750H MEETING TABLE	1
	BLACK LEATHER CHAIR	3
	CEILING BEAM	5M
	RUBBISH BIN & CARPET (15sqm.)	

5M x 3M WORLD OF FINE DINING CORNER BOOTH

五米乘三米角位攤位

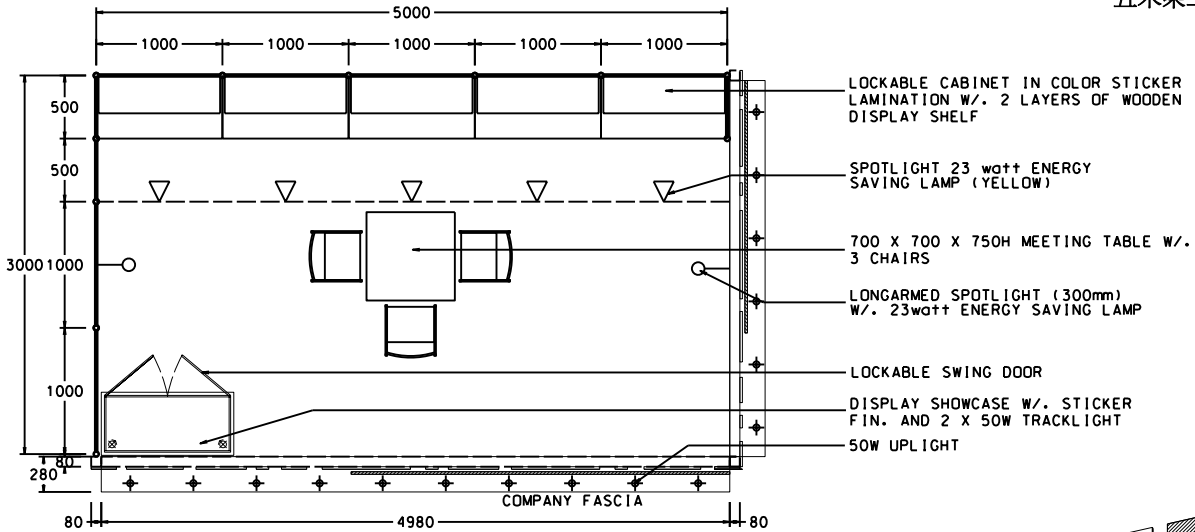

PLAN

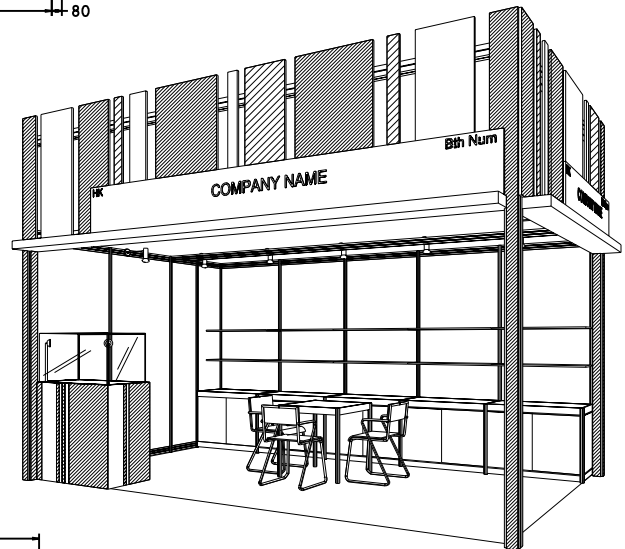

PERSPECTIVE

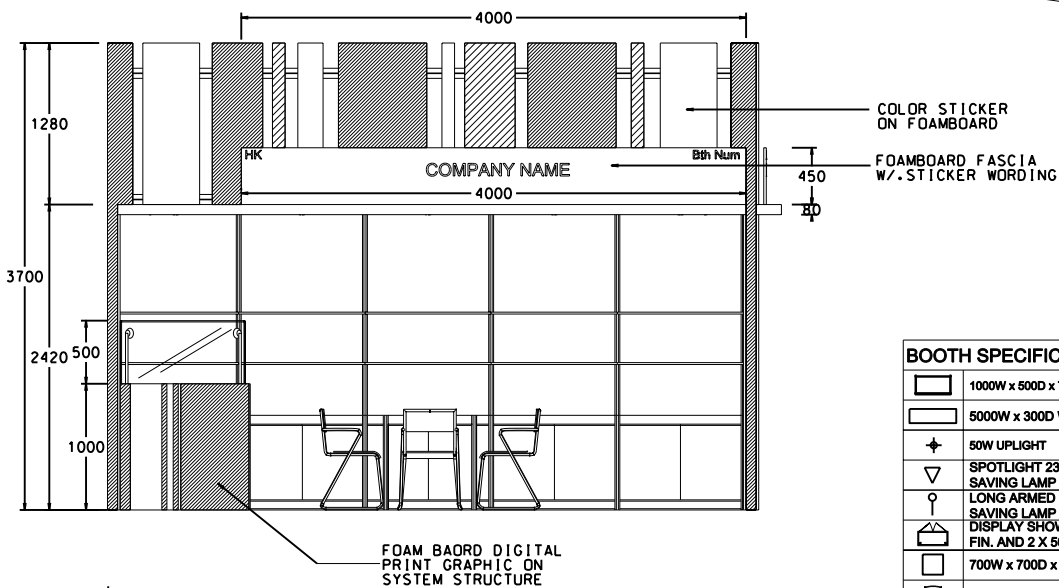

ELEVATION

BOOTH SPECIFICATIONS		QTY.
	1000W x 500D x 750H CABINET	5
	5000W x 300D WOODEN DISPLAY SHELF	2
	50W UPLIGHT	16
	SPOTLIGHT 23 WATT ENERGY SAVING LAMP (YELLOW LIGHT)	5
	LONG ARMED SPOTLIGHT (300MM) 23 WATT ENERGY SAVING LAMP (YELLOW LIGHT)	2
	DISPLAY SHOWCASE W/. STICKER FIN. AND 2 X 50W TRACKLIGHT	1
	700W x 700D x 750H MEETING TABLE	1
	BLACK LEATHER CHAIR	3
	CEILING BEAM	5M
	RUBBISH BIN & CARPET (15sqm.)	

6M x 3M WORLD OF FINE DINING BOOTH

六米乘三米攤位

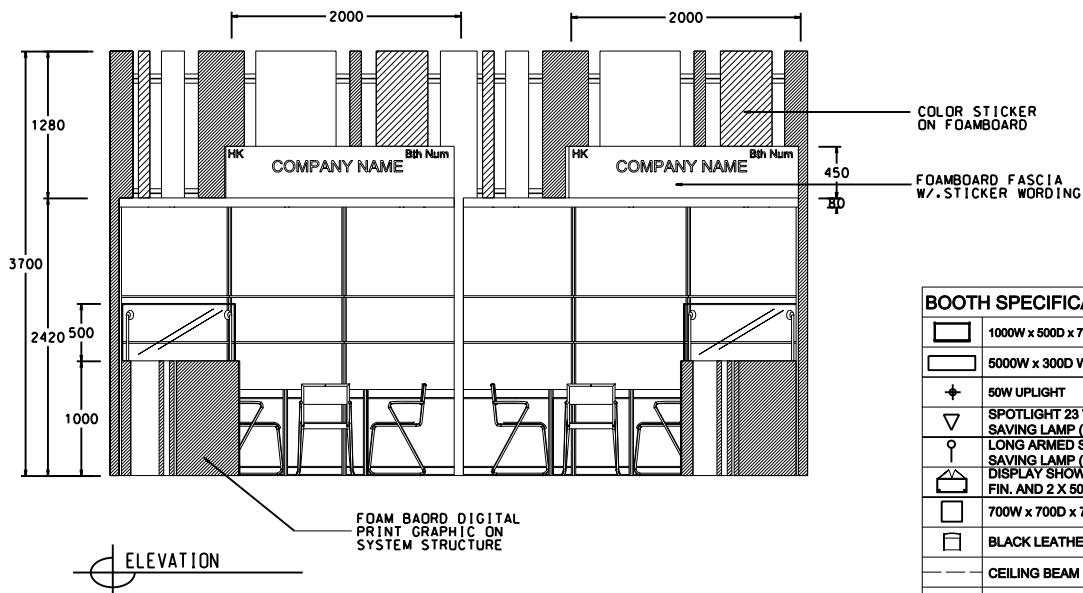
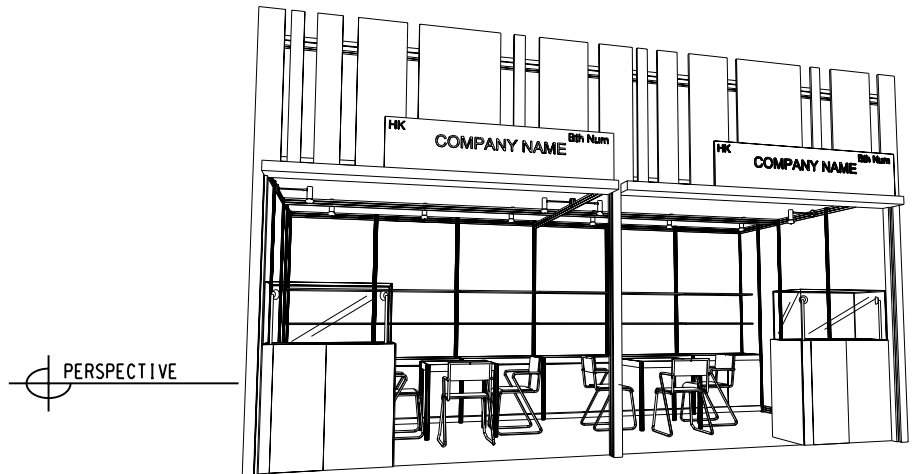
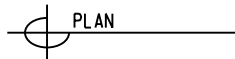
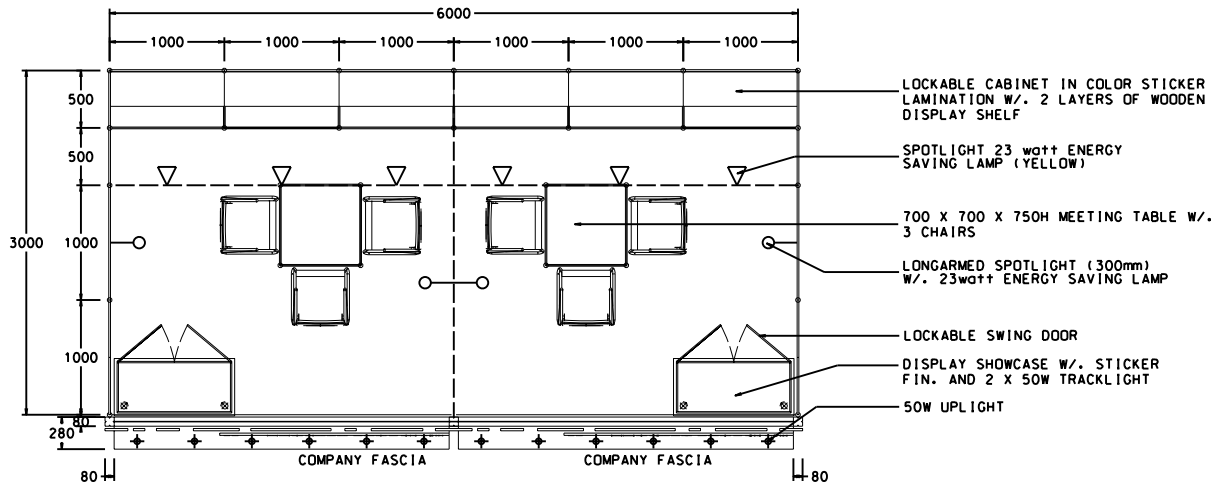

BOOTH SPECIFICATIONS		QTY.
	1000W x 500D x 750H CABINET	6
	5000W x 300D WOODEN DISPLAY SHELF	4
	50W UPLIGHT	12
	SPOTLIGHT 23 WATT ENERGY SAVING LAMP (YELLOW LIGHT)	6
	LONG ARMED SPOTLIGHT (300MM) 23 WATT ENERGY SAVING LAMP (YELLOW LIGHT)	4
	DISPLAY SHOWCASE W/. STICKER FIN. AND 2 X 50W TRACKLIGHT	2
	700W x 700D x 750H MEETING TABLE	2
	BLACK LEATHER CHAIR	6
	CEILING BEAM	9M
	RUBBISH BIN & CARPET (18sqm.)	

6M x 3M WORLD OF FINE DINING CORNER BOOTH

六米乘三米角位攤位

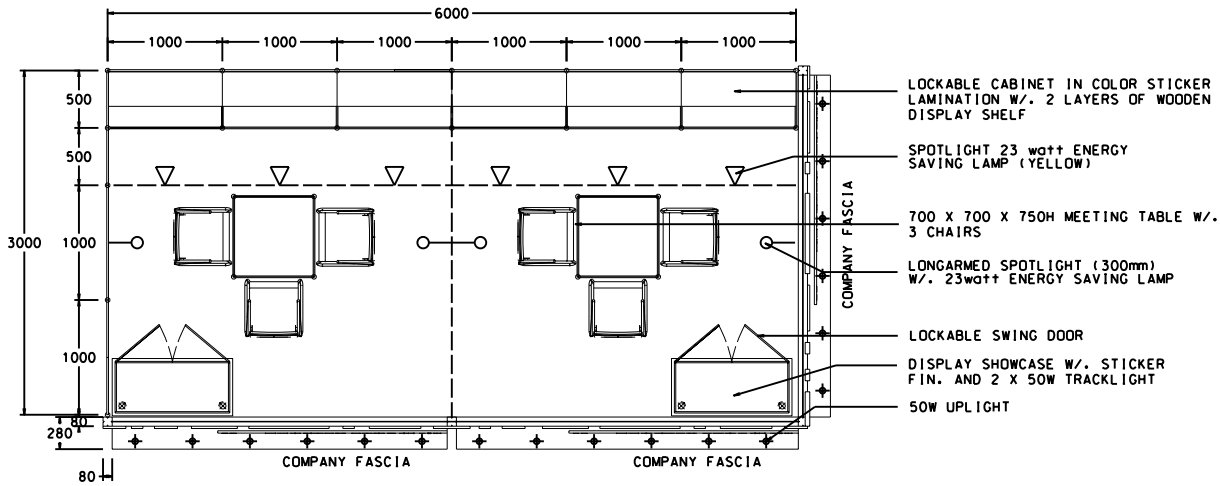

PLAN

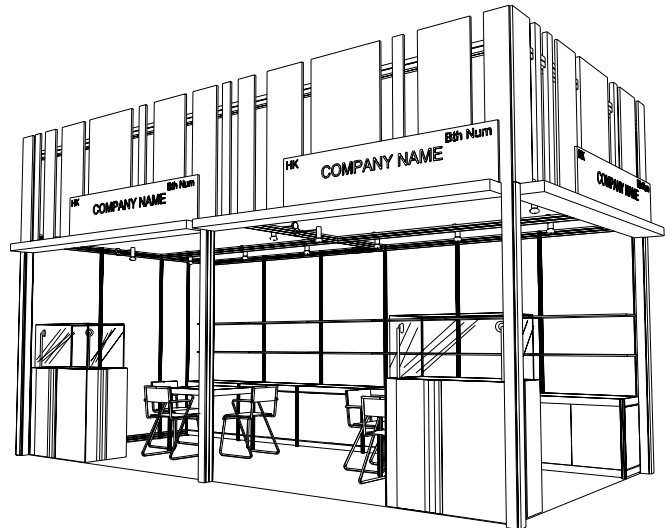

PERSPECTIVE

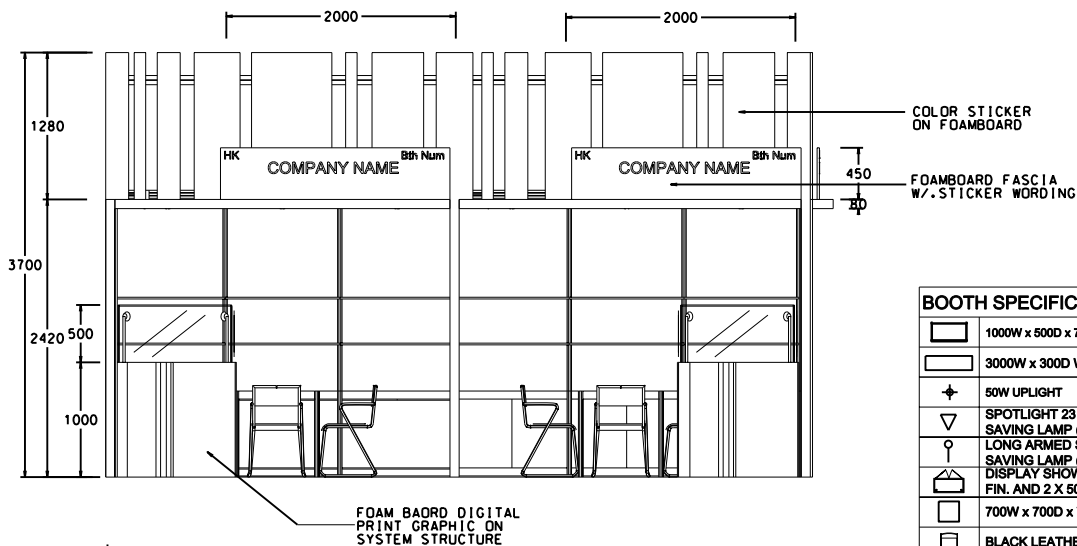

ELEVATION

BOOTH SPECIFICATIONS		QTY.
	1000W x 500D x 750H CABINET	6
	3000W x 300D WOODEN DISPLAY SHELF	4
	50W UPLIGHT	18
	SPOTLIGHT 23 WATT ENERGY SAVING LAMP (YELLOW LIGHT)	6
	LONG ARMED SPOTLIGHT (300MM) 23 WATT ENERGY SAVING LAMP (YELLOW LIGHT)	4
	DISPLAY SHOWCASE W/. STICKER FIN. AND 2 x 50W TRACKLIGHT	2
	700W x 700D x 750H MEETING TABLE	2
	BLACK LEATHER CHAIR	6
	CEILING BEAM	9M
	RUBBISH BIN & CARPET (18sqm.)	

6M x 6M WORLD OF FINE DINING CORNER BOOTH

六米乘六米角位攤位

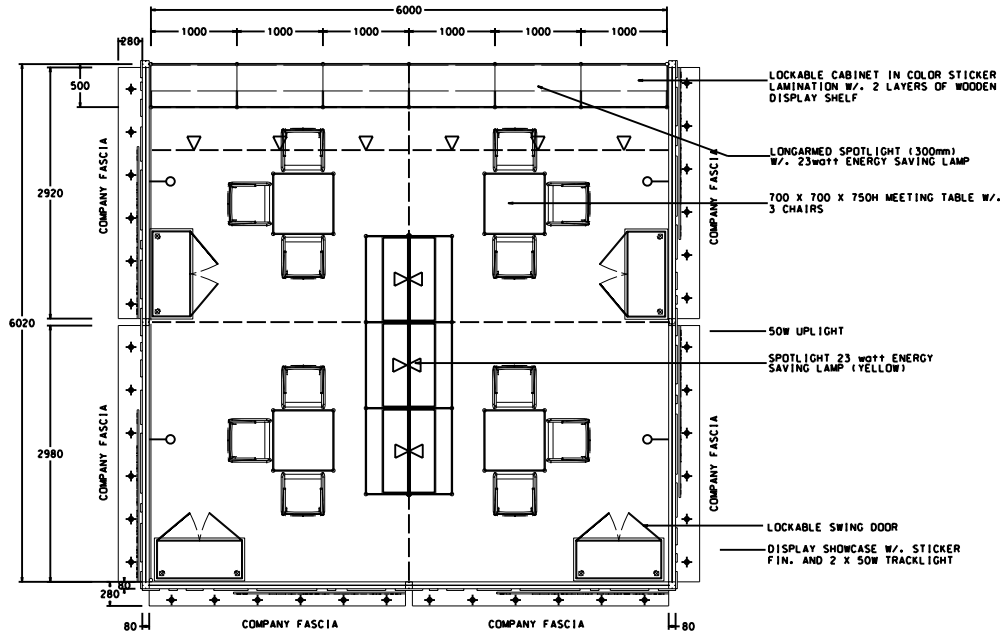

PLAN

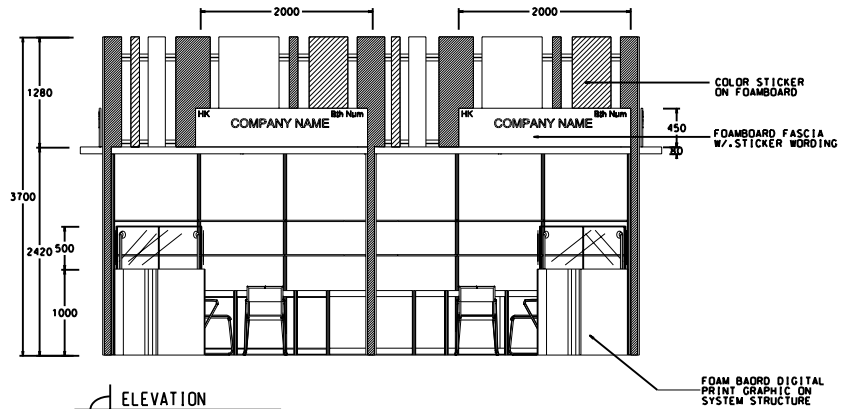

ELEVATION

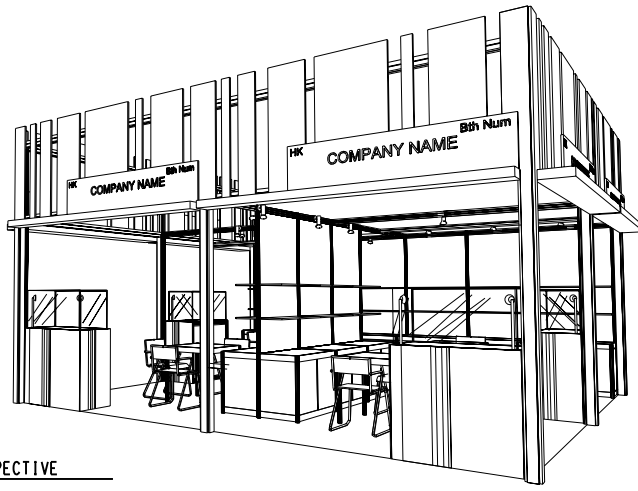

PERSPECTIVE

BOOTH SPECIFICATIONS		QTY.
	1000W x 500D x 750H CABINET	12
	3000W x 300D WOODEN DISPLAY SHELF	8
	50W UPLIGHT	36
	SPOTLIGHT 23 WATT ENERGY SAVING LAMP (YELLOW LIGHT)	12
	LONG ARMED SPOTLIGHT (300MM) 23 WATT ENERGY SAVING LAMP (YELLOW LIGHT)	8
	DISPLAY SHOWCASE W/ STICKER FIN. AND 2 X 50W TRACKLIGHT	4
	700W x 700D x 750H MEETING TABLE	4
	BLACK LEATHER CHAIR	12
	CEILING BEAM	12M
	RUBBISH BIN & CARPET (36sqm.)	

Hong Kong Houseware Fair

香港家庭用品展

8M x 3M WORLD OF FINE DINING CORNER BOOTH

八米乘三米角位攤位

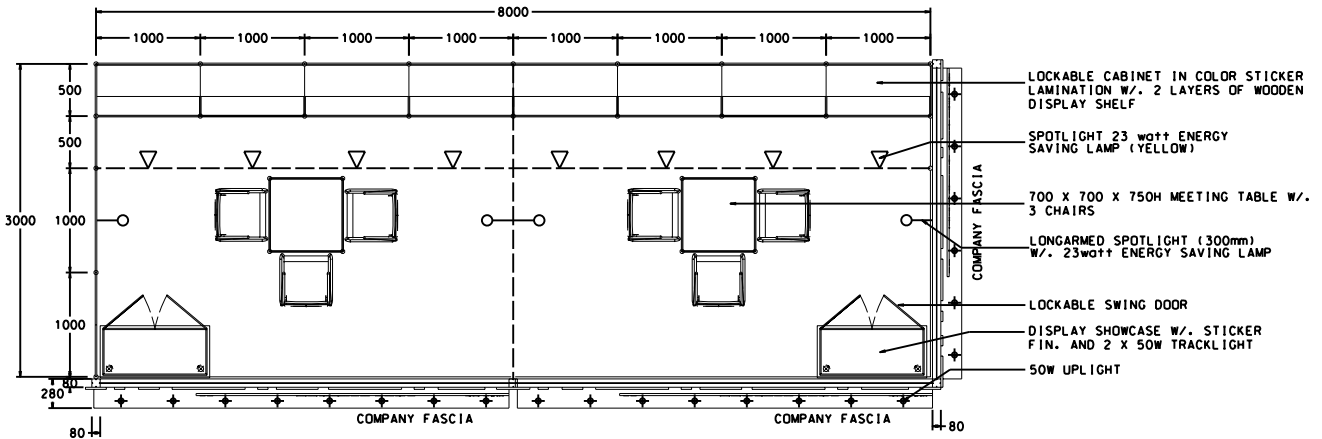

PLAN

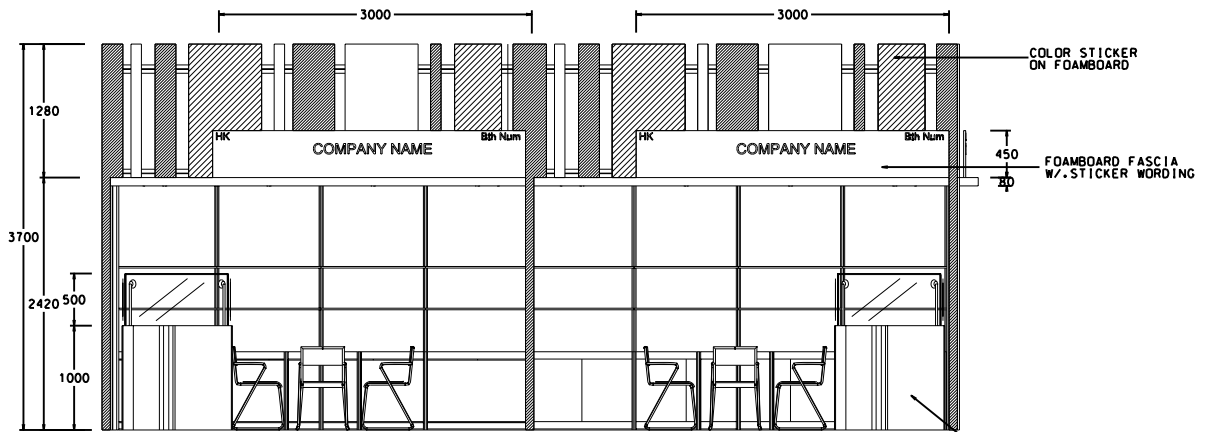

ELEVATION

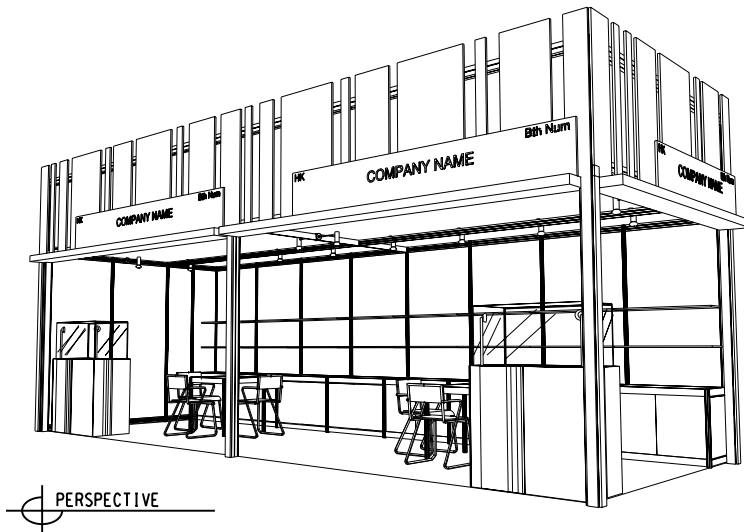

PERSPECTIVE

BOOTH SPECIFICATIONS		QTY.
	1000W x 500D x 750H CABINET	8
	2000W x 300D WOODEN DISPLAY SHELF	8
	50W UPLIGHT	22
	SPOTLIGHT 23 WATT ENERGY SAVING LAMP (YELLOW LIGHT)	8
	LONG ARMED SPOTLIGHT (300MM) 23 WATT ENERGY SAVING LAMP (YELLOW LIGHT)	4
	DISPLAY SHOWCASE W/. STICKER FIN. AND 2 X 50W TRACKLIGHT	2
	700W x 700D x 750H MEETING TABLE	2
	BLACK LEATHER CHAIR	6
	CEILING BEAM	11M
	RUBBISH BIN & CARPET (24sqm.)	

9M x 3M WORLD OF FINE DINING CORNER BOOTH

九米乘三米角位攤位

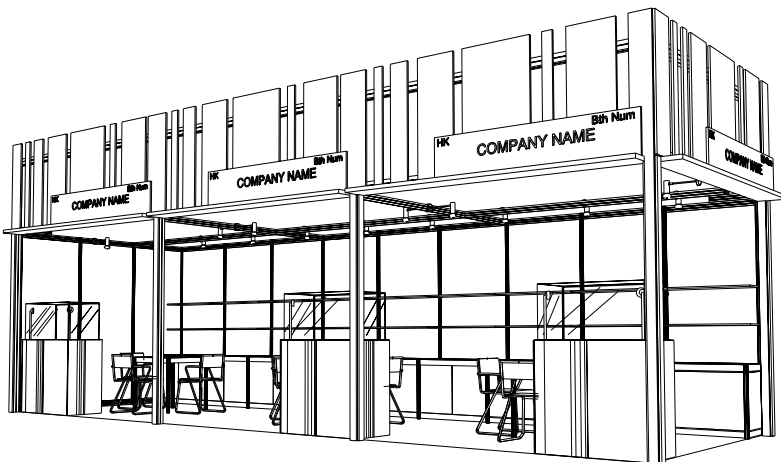
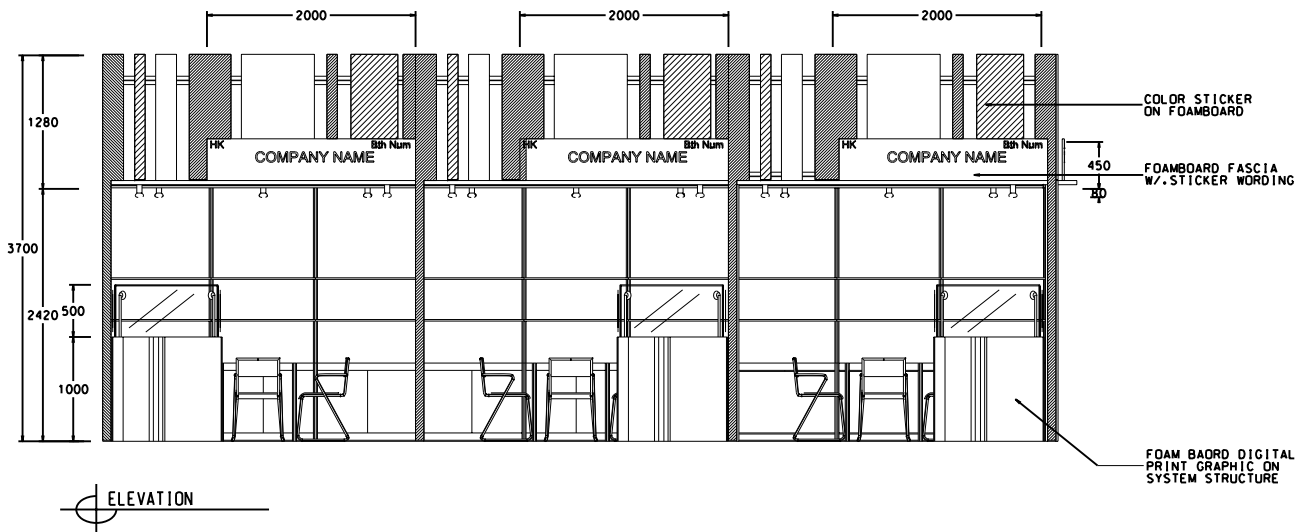
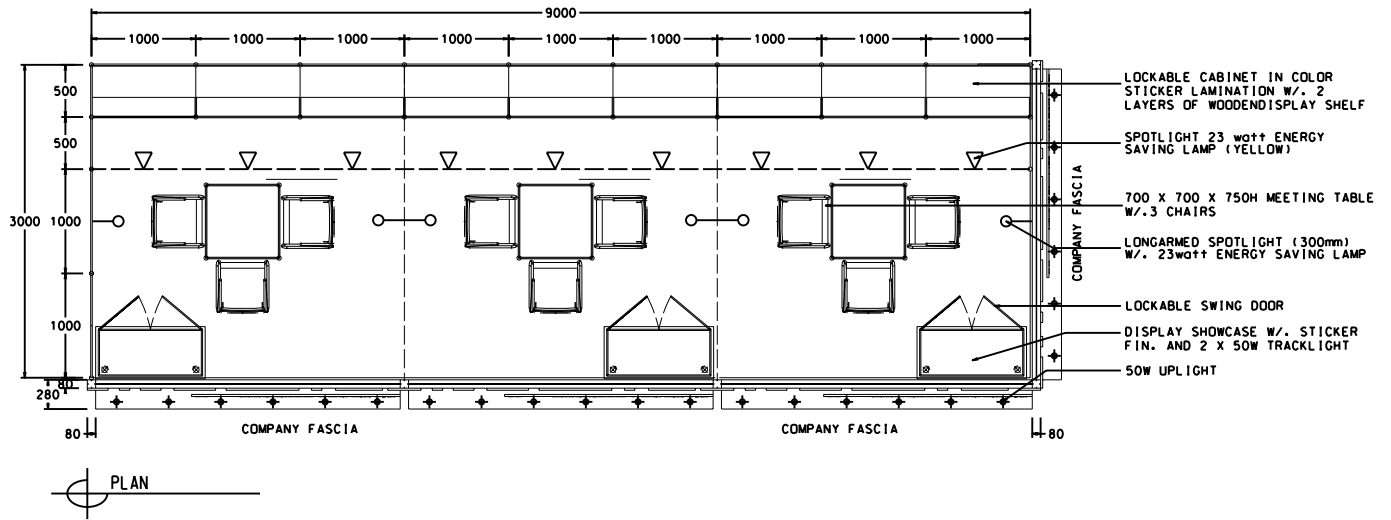

BOOTH SPECIFICATIONS		QTY.
	1000W x 500D x 750H CABINET	9
	3000W x 300D WOODEN DISPLAY SHELF	6
	50W UPLIGHT	24
	SPOTLIGHT 23 WATT ENERGY SAVING LAMP (YELLOW LIGHT)	9
	LONG ARMED SPOTLIGHT (300MM) 23 WATT ENERGY SAVING LAMP (YELLOW LIGHT)	6
	DISPLAY SHOWCASE W/ STICKER FIN. AND 2 x 50W TRACKLIGHT	3
	700W x 700D x 750H MEETING TABLE	3
	BLACK LEATHER CHAIR	9
	CEILING BEAM	15
	RUBBISH BIN & CARPET (27sqm.)	

10M x 3M WORLD OF FINE DINING CORNER BOOTH

十米乘三米角位攤位

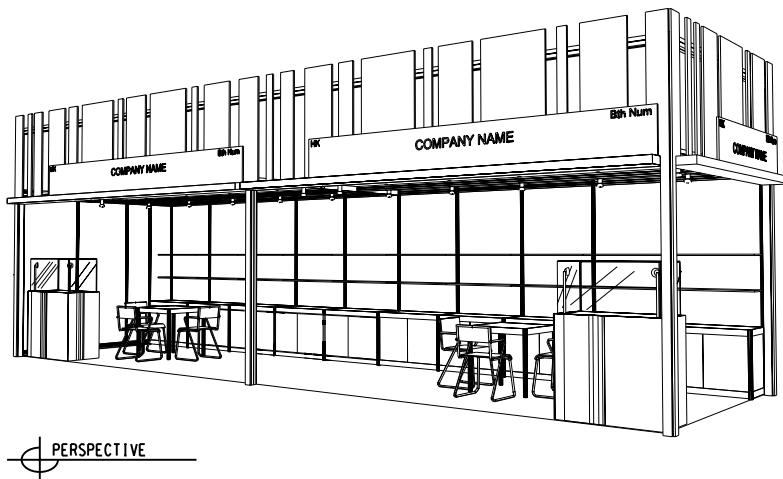
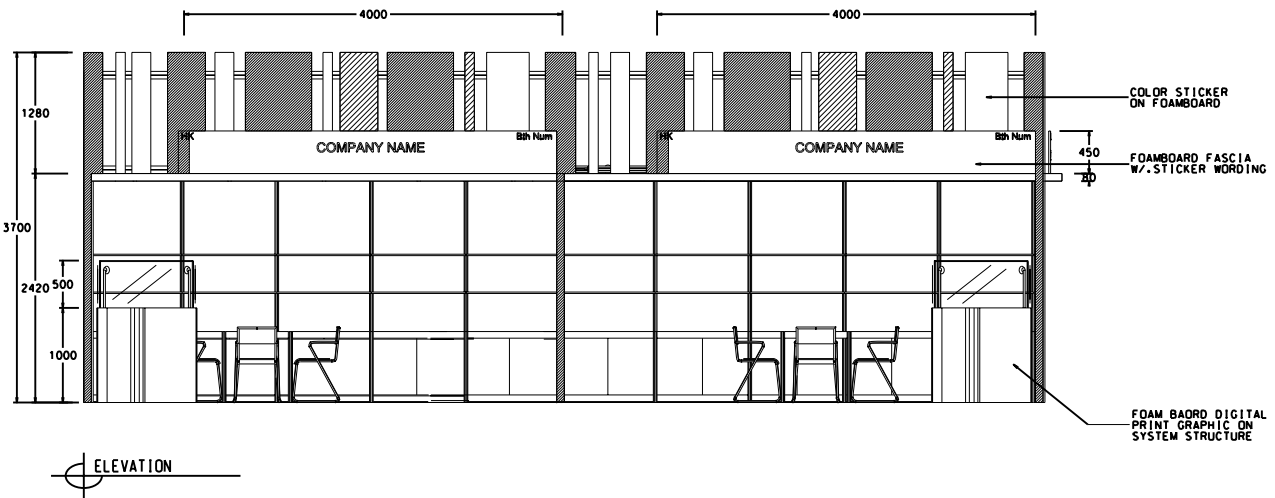
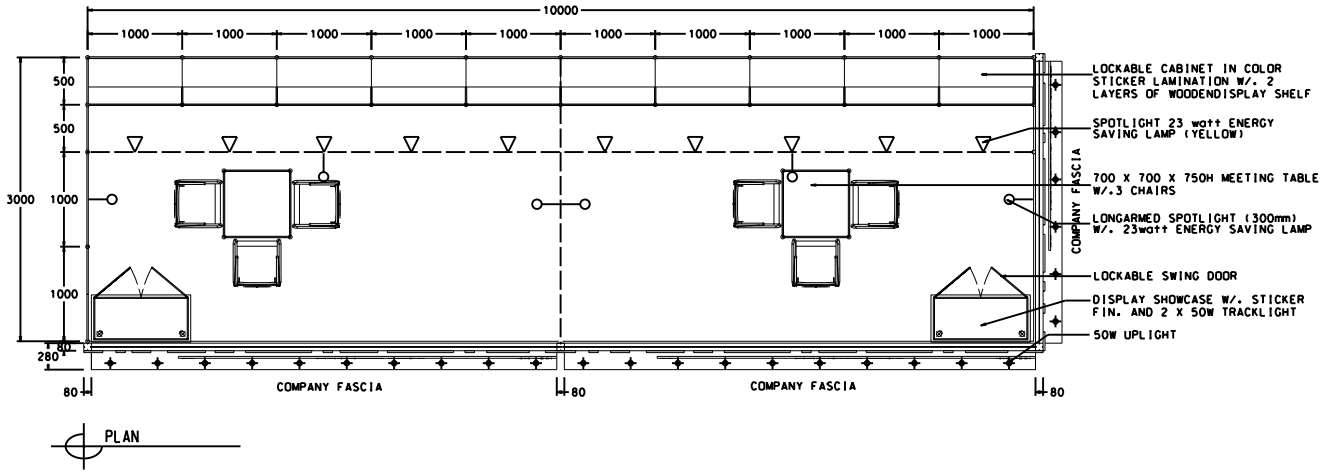

BOOTH SPECIFICATIONS		QTY.
	1000W x 500D x 750H CABINET	10
	5000W x 300D WOODEN DISPLAY SHELF	4
	50W UPLIGHT	26
	SPOTLIGHT 23 WATT ENERGY SAVING LAMP (YELLOW LIGHT)	10
	LONG ARMED SPOTLIGHT (300MM) 23 WATT ENERGY SAVING LAMP (YELLOW LIGHT)	6
	DISPLAY SHOWCASE W/ STICKER FIN. AND 2 X 50W TRACKLIGHT	2
	700W x 700D x 750H MEETING TABLE	3
	BLACK LEATHER CHAIR	9
	CEILING BEAM	13M
	RUBBISH BIN & CARPET (30sqm.)	